



Longway® is a modular system of narrow and wide ribbons of upholstered seating which undulate to form seats and armrests creating large central or terminal curved lines. Longway enhances an environments' quality with its particular play of shapes: the basic composition creates results never seen before, the alternation of curves and horizontal planes offers a marked visual impact. The broadness and versatility of the collection allows limitless compositions. **The collection includes single and modular elements:** benches, sofas and tables (Longway® tables) that forms islands, linear, angular benches, "C" or curved compositions and is aimed particularly to contract environments such as lobby, waiting

room, shopping centers, airports, hotels, showrooms. Longway® is also suitable for semi-public spaces as stay, relax and informal meeting area.

The large plan is suspended between floor armrests or on brushed stainless steel legs, powder coated or satin chromed steel legs. The internal frame is constructed of steel and upholstery of different densities of non-deformable polyurethane foam, lining of polyester padding.

For articles IH/IW09, IH/IW10, IH/IW41, IH/IW42, IH/IW70, IH/IW72 and IH/IW73 the internal frame is in plywood.

The modules IH11/IW11 and IH12/IW12 have the internal frame in steel and cold injected

polyurethane foam.

Fire retardant inner padding meets "California Bulletin 117A" and "Italian Class 1 IM" Standards.

Special foam meeting the 5852 British Standards is available on request.

Covers are available in fabric, faux-leather or C.O.M. (preferably in solid colours). Possibility of upholstery using different materials or two colours of the same material with additional cost.

Seat height           IH: 38 cm  
                                  IW: 42 cm

For Longway® tables see "Tables" section.  
For Longway® outdoor see page 168.

## Configurations



A drawing of the required configuration must accompany your order

# LONGWAY® - A

Bartoli Design / 2007



Bench with central armrest  
with or without backrest, with the possibility  
to assemble in different way.



	Article	Upholstery	Powder coated legs	Satin chromed legs 03	Brushed stainless steel legs 66	pcs / dimensions volume / gross weight product net weight
<b>Module A</b>	IH01 - H. 38 cm	Gazebo				1 pc / 285x48x74 cm 1,01 m3 / 74 Kg 65 Kg
	IW01 - H. 42 cm	Xtreme Plus / Magnum / Rivet / Sprint / Main Line Flax Blazer / Gingko / Step Melange / Silvertex Steelcut Trio3 C.O. faux leather / C.O.M. (solid colour)				
<b>S2</b> backrest for Longway A for modular composition only	IHS2	Gazebo Xtreme Plus / Magnum / Rivet / Sprint / Main Line Flax Blazer / Gingko / Step Melange / Silvertex Steelcut Trio3 C.O. faux leather / C.O.M. (solid colour)				1 pc / 249x28x49 cm 0,34 m3 / 24 Kg 22 Kg

## Accessories

Ganging device, powder coated black 08  
MGANH0108

## Additional costs

Upholstery in two different materials  
or two colours of the same material  
Floor anchoring system (per each leg)

## Finishes

### Legs

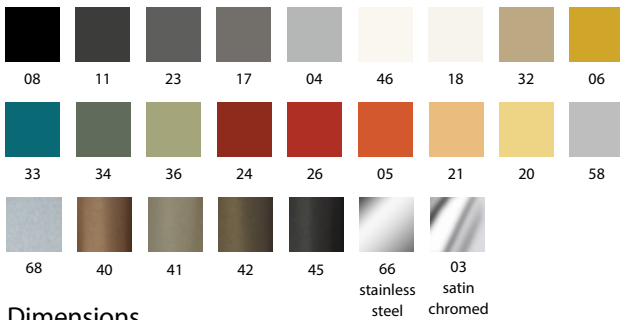

## Customer's own material

For customer's own material, the form at the end of the price list shall apply, to be sent to Segis Spa with the Client's signature.

Solid fabric for 1 pc 515 cm (H.140 cm)  
Upholstery in two colours:  
or 1 pc seat 515 cm (H.140 cm)  
lateral sides 179 cm (H.140 cm)

## Fire retardant certifications

Art. IH01 The product upholstered with Xtreme fabric and Gazebo faux-leather meets Class 11M Standards by the Italian Minister of Interior.

## Dimensions

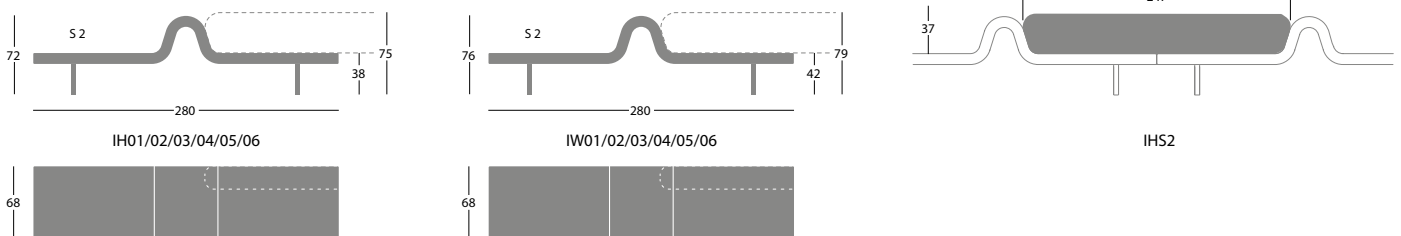
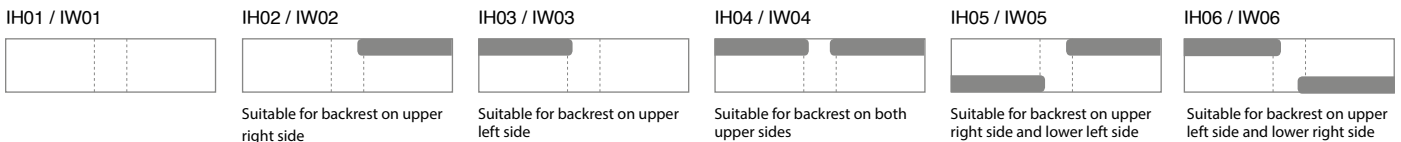



Bench with two different seat heights



	Article	Upholstery	Powder coated legs	Satin chromed legs 03	Brushed stainless steel legs 66	pcs / dimensions volume / gross weight product net weight
<b>Module B</b>	IH20 - H. 38 cm IW20 - H. 42 cm	Gazebo Xtreme Plus / Magnum / Rivet / Sprint / Main Line Flax Blazer / Gingko / Step Melange / Silvertex Steelcut Trio3 C.O. faux leather / C.O.M. (solid colour)				1 pc / 339x28x74 cm 0,69 m3 / 80 Kg 69,5 Kg

## Finishes

### Legs

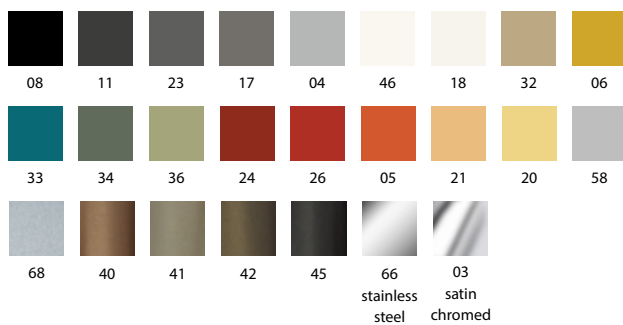

## Accessories

Ganging device, powder coated in black 08 art. MGANH0108

## Additional costs

Upholstery in two different materials or two colours of the same material  
Floor anchoring system (per each leg)

## Customer's own material

For customer's own material, the form at the end of the price list shall apply, to be sent to Segis Spa with the Client's signature.

Solid fabric for 1 pc 515 cm (H.140 cm)  
Upholstery in two colours:  
or 1 pc seat 515 cm (H.140 cm)  
lateral sides 179 cm (H.140 cm)

## Dimensions

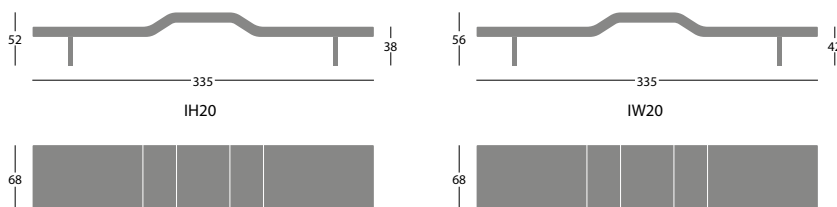

## Fire retardant certifications

Art. IH20 The product upholstered with Xtreme fabric and Gazebo faux-leather meets Class 1IM Standards by the Italian Minister of Interior.

Bench with side armrest



	Article	Upholstery	Powder coated legs	Satin chromed legs 03	Brushed stainless steel legs 66	pcs / dimensions volume / gross weight product net weight
<b>Module C</b>	IH30 - H. 38 cm IW30 - H. 42 cm	Gazebo Xtreme Plus / Magnum / Rivet / Sprint / Main Line Flax Blazer / Gingko / Step Melange / Silvertex Steelcut Trio3 C.O. faux leather / C.O.M. (solid colour)				1 pc / 285x77x74 cm 1,62 m3 / 71,5 Kg 63 Kg

## Finishes

### Legs

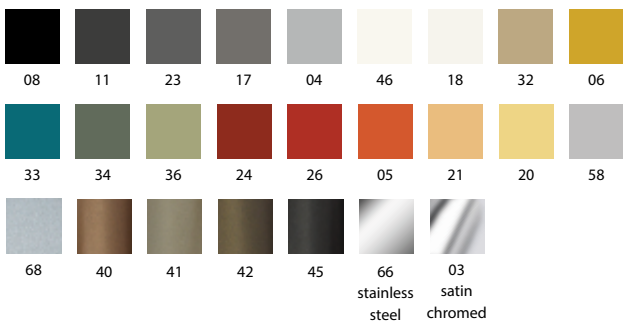

## Dimensions

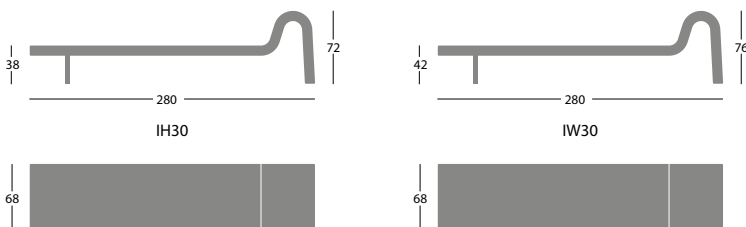

## Additional costs

Upholstery in two different materials  
or two colours of the same material  
Floor anchoring system (for metal leg)

## Accessories

Ganging device, powder coated  
in black 08 art. MGANH0108  
Floor anchoring system with stainless steel  
cover ( for upholstered legs) C0H50



## Customer's own material

For customer's own material, the form at the end of the price list shall apply, to be sent to Segis Spa with the Client's signature.

Solid fabric for 1 pc 693 cm (H.140 cm)

Upholstery in two colours:

or 1 pc seat 683 cm (H.140 cm)

lateral sides 315 cm (H.140 cm)

## Fire retardant certifications

Art. IH30 The product upholstered with Xtreme fabric and Gazebo faux-leather meets Class 1IM Standards by the Italian Minister of Interior.

# LONGWAY® - D / H / I

Bartoli Design / 2007



Longway H - Curved bench 45° R. 110 cm.

Longway I - Curved bench 60° R. 68 cm

Longway D - Angle ottoman

The position of the leg changes according to the composition.

Benches and non self standing elements to use only in a modular composition.



	Article	Upholstery	Powder coated legs	Satin chromed legs 03	Brushed stainless steel legs 66	pcs / dimensions volume / gross weight product net weight
<b>Module D</b>	IH72 - H. 38 cm	Gazebo				1 pc / 71x71x44 cm 0,22 m <sup>3</sup> / 17,5 Kg 13,5 Kg
	IW72 - H. 42 cm	Xtreme Plus / Magnum / Rivet / Sprint / Main Line Flax Blazer / Gingko / Step Melange / Silvertex Steelcut Trio3 C.O. faux leather / C.O.M. (solid colour)				
<b>Module H</b>	IH41 - H. 38 cm	Gazebo				1 pc / 140x20x85 cm 0,23 m <sup>3</sup> / 25,5 Kg 21,5 Kg
	IW41 - H. 42 cm	Xtreme Plus / Magnum / Rivet / Sprint / Main Line Flax Blazer / Gingko / Step Melange / Silvertex Steelcut Trio3 C.O. faux leather / C.O.M. (solid colour)				
<b>Module I</b>	IH42 - H. 38 cm	Gazebo				1 pc / 138x18x85 cm 0,21 m <sup>3</sup> / 24,5 Kg
	IW42 - H. 42 cm	Xtreme Plus / Magnum / Rivet / Sprint / Main Line Flax Blazer / Gingko / Step Melange / Silvertex Steelcut Trio3 C.O. faux leather / C.O.M. (solid colour)				

## Finishes

### Legs

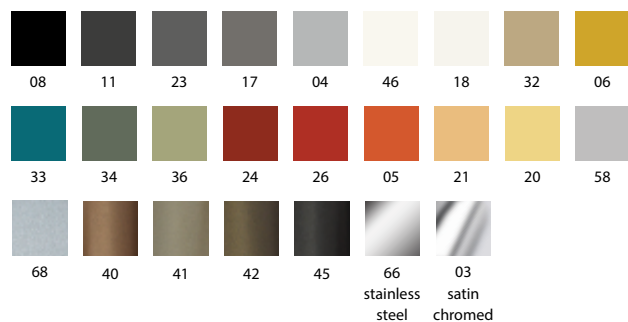

## Accessories

Ganging device, powder coated  
in black 08 - MGANH0108

Ganging device, powder coated  
in black 08 (art. IH41/IH42) - MGANH4008

## Additional costs

Upholstery in two different materials  
or two colours of the same material

Floor anchoring system (per each leg)

## Customer's own material

For customer's own material, the form at the end of the price list shall apply, to be sent to Segis Spa with the Client's signature.

**Longway D** Solid fabric for 1 pc:

per 1 pc 95 cm (H.140 cm)

Upholstery in two colours:  
or 1 pc seat 84 cm (H.140 cm) - lateral sides  
32 cm (H.140 cm)

**Longway H-I** Solid fabric for 1 pc 189 cm (H.140 cm)

Upholstery in two colours:  
or 1 pc seat 157 cm (H.140 cm) - lateral sides 157 cm  
(H.140 cm)

## Dimensions

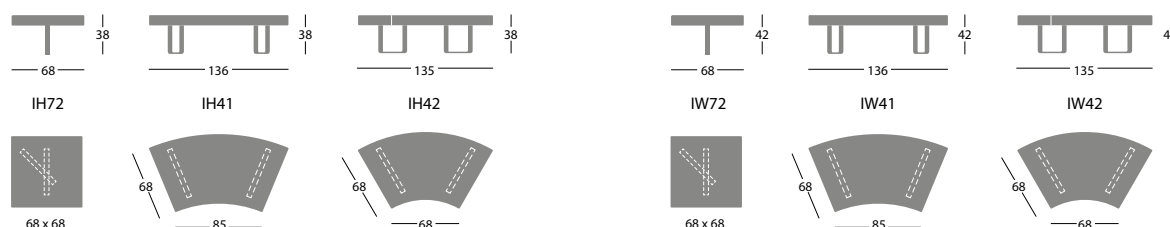

# LONGWAY® - E

Bartoli Design / 2007

segis

Curved bench 90° R.110 with central arm

IH39 / IW39: self-supporting module (4 legs).

IH40 / IW40: non self-supporting module, to use only in a modular composition (2 legs).



	Article	Upholstery	Powder coated legs	Satin chromed legs 03	Brushed stainless steel legs 66	pcs / dimensions volume / gross weight product net weight
<b>Module E</b>	IH39 - H. 38 cm	Gazebo				1 pc / 259x48x103 cm 1,29 m <sup>3</sup> / 71,5 Kg 54 Kg
	IW39 - H. 42 cm	Xtreme Plus / Magnum / Rivet / Sprint / Main Line Flax Blazer / Gingko / Step Melange / Silvertex Steelcut Trio3 C.O. faux leather / C.O.M. (solid colour)				
<b>Module E</b> To use only in a modular composition	IH40 - H. 38 cm	Gazebo				1 pc / 259x48x103 cm 1,29 m <sup>3</sup> / 67,5 Kg 50 Kg
	IW40 - H. 42 cm	Xtreme Plus / Magnum / Rivet / Sprint / Main Line Flax Blazer / Gingko / Step Melange / Silvertex Steelcut Trio3 C.O. faux leather / C.O.M. (solid colour)				

## Finishes

### Legs

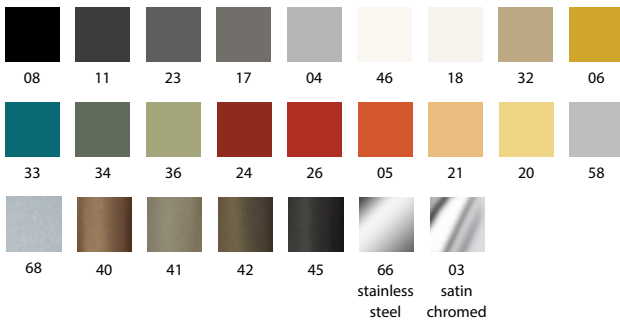

## Dimensions

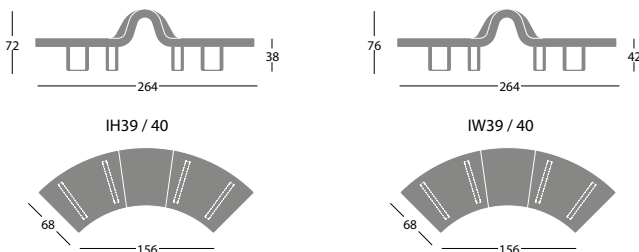

## Accessories

Ganging device, powder coated in black 08 art.MGANH4008

## Additional costs

Upholstery in two different materials or two colours of the same material  
Floor anchoring system (per each leg)

## Customer's own material

For customer's own material, the form at the end of the price list shall apply, to be sent to Segis Spa with the Client's signature.

Solid fabric for 1 pc 588 cm (H.140 cm)  
Upholstery in two colours: or 1 pc seat 462 cm (H.140 cm) - lateral sides 158 cm (H.140 cm)

# LONGWAY® - F

Bartoli Design / 2007

segis

Sofa bench with or without backrest



	Article	Upholstery	pcs / dimensions volume / gross weight product net weight
<b>Module F</b>	IH50 - H. 38 cm	Gazebo	1 pc / 285x77x74 cm 1,60 m <sup>3</sup> / 82,5 Kg 74 Kg
	IW50 - H. 42 cm	Xtreme Plus / Magnum / Rivet / Sprint / Main Line Flax Blazer / Gingko / Step Melange / Silvertex Steelcut Trio3 C.O. faux leather / C.O.M. (solid colour)	
<b>Module F with backrest</b>	IH60 - H. 38 cm	Gazebo	1 pc / 285x80x74 cm 1,70 m <sup>3</sup> / 100,5 Kg 87 Kg
	IW60 - H. 42 cm	Xtreme Plus / Magnum / Rivet / Sprint / Main Line Flax Blazer / Gingko / Step Melange / Silvertex Steelcut Trio3 C.O. faux leather / C.O.M. (solid colour)	

## Additional costs

Upholstery in two different materials  
or two colours of the same material

## Accessories

Floor anchoring system with stainless steel  
cover for upholstered legs) C0H50



## Dimensions

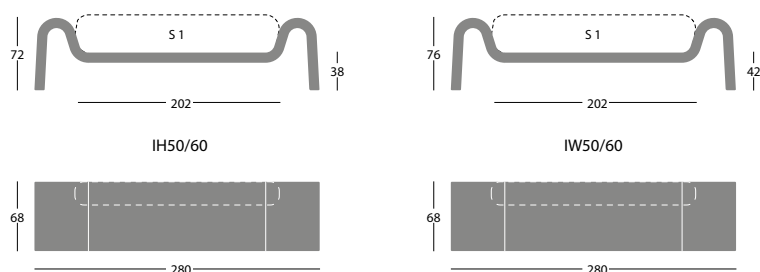

## Customer's own material

For customer's own material, the form at the end of the price list shall apply, to be sent to Segis Spa with the Client's signature.

**Longway F Solid fabric for 1 pc:** 777 cm (H.140 cm)  
Upholstery in two colours: or 1 pc seat 756 cm (H.140 cm) -  
lateral sides 262 cm (H.140 cm)

**Backrest:** solid fabric for 1 pc. backrest 225 cm (width 140 cm)

## Resistance tests

ANSI-BIFMA 5.4 - 2005/13 - seating durability - cyclic  
ANSI-BIFMA 5.4 - 2005/12 - arm durability - cyclic  
ANSI-BIFMA 5.4 - 2005/15 - structural durability - cyclic Test  
ANSI-BIFMA 5.4 - 2005/10 - arm strength - vertical, static Test  
ANSI-BIFMA 5.4 - 2005/14 - drop test - dynamic  
ANSI-BIFMA 5.4 - 2005/17 - leg strength - front & side application  
ANSI-BIFMA 5.4 - 2005/18 - unit drop test - dynamic  
ANSI-BIFMA 5.4 - 2005/22 - stability

# LONGWAY® - G / M

Bartoli Design / 2007

segls

## G

### Rectangular bench

Bench or joining element, to be used alone or in a modular composition.

## M

### Hexagonal bench

Bench or joining element, to be used alone or in a modular composition.



G



M

	Article	Upholstery	Powder coated legs	Satin chromed legs 03	Brushed stainless steel legs 66	pcs / dimensions volume / gross weight product net weight
<b>Module G</b>	IH73 - H. 38 cm	Gazebo				1 pc / 144x18x74 cm 0,19 m3 / 28 Kg 24 Kg
	IW73 - H. 42 cm	Xtreme Plus / Magnum / Rivet / Sprint / Main Line Flax Blazer / Gingko / Step Melange / Silvertex Steelcut Trio3 C.O. faux leather / C.O.M. (solid colour)				
<b>Module M</b>	IH70 - H. 38 cm	Gazebo				1 pc / 138x18x119 cm 0,29 m3 / 34 Kg 28,5 Kg
	IW70 - H. 42 cm	Xtreme Plus / Magnum / Rivet / Sprint / Main Line Flax Blazer / Gingko / Step Melange / Silvertex Steelcut Trio3 C.O. faux leather / C.O.M. (solid colour)				

## Finishes

### Legs

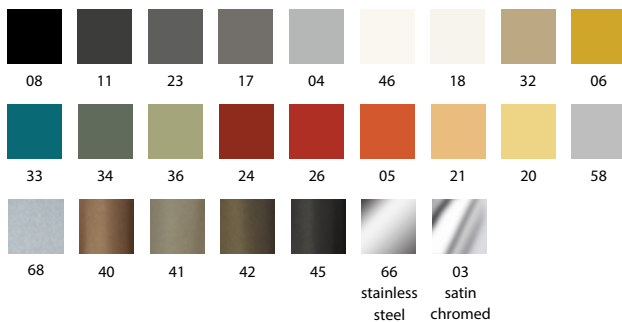

## Accessories

Ganging device, powder coated in black 08 art. MGANH0108

## Additional costs

Upholstery in two different materials

or two colours of the same material

Floor anchoring system (per each leg)

## Customer's own material

For customer's own material, the form at the end of the price list shall apply, to be sent to Segis Spa with the Client's signature.

**Longway G** Solid fabric for 1 pc: 157 cm (H.140 cm)

Upholstery in two colours: or 1 pc seat 157 cm (H.140 cm) - lateral sides 157 cm (H.140 cm)

**Longway M** Solid fabric for 1 pc: 262 cm (H.140 cm)

Upholstery in two colours: or 1 pc seat 195 cm (H.140 cm) - lateral sides 84 cm (H.140 cm)

## Dimensions

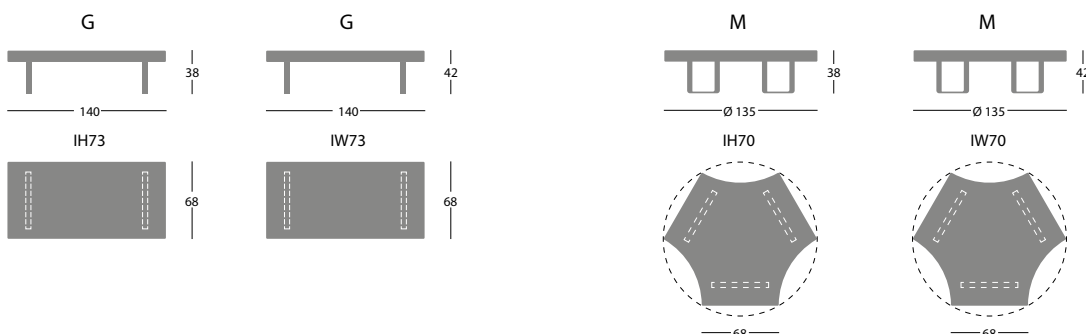



# LONGWAY® - L

Bartoli Design / 2007

segis

"Loop" seating element  
(2 pieces linked together to be assembled)



	Article	Upholstery	Powder coated legs	Satin chromed legs 03	Brushed stainless steel legs 66	pcs / dimensions volume / gross weight product net weight
<b>Module L</b>	IH74 - H. 38 cm IW74 - H. 42 cm	Gazebo Xtreme Plus / Magnum / Rivet / Sprint / Main Line Flax Blazer / Gingko / Step Melange / Silvertex Steelcut Trio3 C.O. faux leather / C.O.M. (solid colour)				1 pc / 188x88x112 cm (2 boxes of same dimensions) 3,7 m <sup>3</sup> / 122 Kg 102 Kg

## Finishes

### Legs

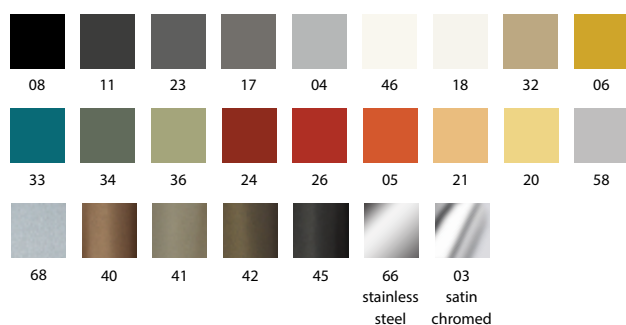

## Dimensions

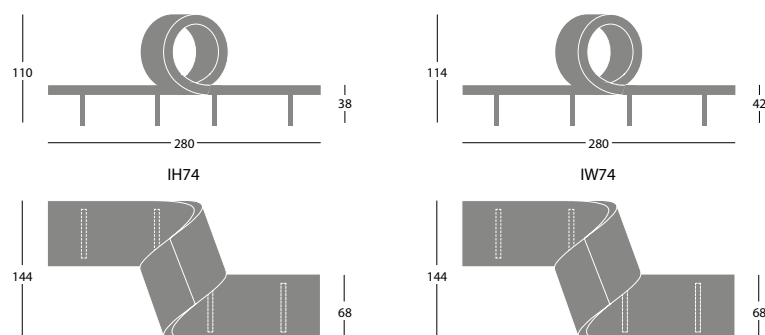

## Accessories

Ganging device, powder coated  
in black 08 art. MGANH0108

## Additional costs

Upholstery in two different materials  
or two colours of the same material  
Floor anchoring system (per each leg)

## Customer's own material

For customer's own material, the form at the end of the price list shall apply, to be sent to Segis Spa with the Client's signature.

Solid fabric for 1 pc 892 cm (H.140 cm)  
Upholstery in two colours: or 1 pc seat 609 cm (H.140 cm)  
lateral sides 283 cm (H.140 cm)

## Armchair



	Article	Upholstery	Powder coated legs	Satin chromed legs 03	Brushed stainless steel legs 66	pcs / dimensions volume / gross weight product net weight
<b>Module N</b>	IH07 - H. 38 cm IW07 - H. 42 cm	Gazebo Xtreme Plus / Magnum / Rivet / Sprint / Main Line Flax Blazer / Gingko / Step Melange / Silvertex Steelcut Trio3 C.O. faux leather / C.O.M. (solid colour)				1 pc / 104x76x72 cm 0,57 m3 / 39,5 Kg 35,0 Kg

## Finishes

## Legs

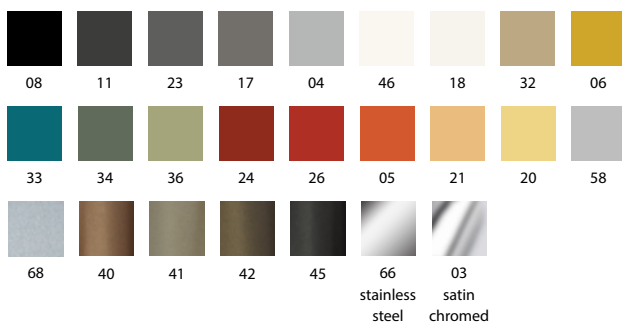

## Dimensions

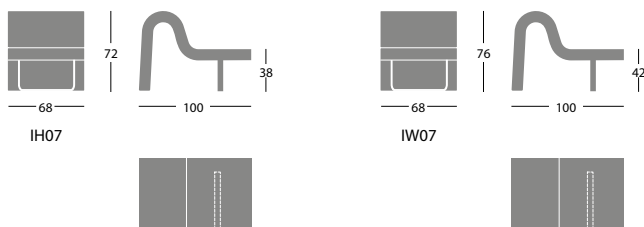

## Additional costs

*Upholstery in two different materials  
or two colours of the same material  
Floor anchoring system (for metal leg)*

## Accessories

*Ganging device, powder coated  
in black 08 art. MGANH0108  
Floor anchoring system with stainless steel  
cover for upholstered legs) C0H50*



## Customer's own material

*For customer's own material, the form at the end of the price list shall apply, to be sent to Segis Spa with the Client's signature.*

*Solid fabric for 1 pc 315 cm (H.140 cm)  
Upholstery in two colours:  
or 1 pc seat 189 cm (H.140 cm)  
lateral sides 126 cm (H.140 cm)*

# LONGWAY® - O

Bartoli Design / 2007

segis

Chaise longue  
with headrest (64x30 H cm)



	Article	Upholstery	Powder coated legs	Satin chromed legs 03	Brushed stainless steel legs 66	pcs / dimensions volume / gross weight product net weight
<b>Module O</b>	IH08 - H. 38 cm IW08 - H. 42 cm	Gazebo Xtreme Plus / Magnum / Rivet / Sprint / Main Line Flax Blazer / Gingko / Step Melange / Silvertex Steelcut Trio3 C.O. faux leather / C.O.M. (solid colour)				1 pc / 194x94x72 cm 1,29 m3 / 54 Kg 45 Kg

## Finishes

### Legs

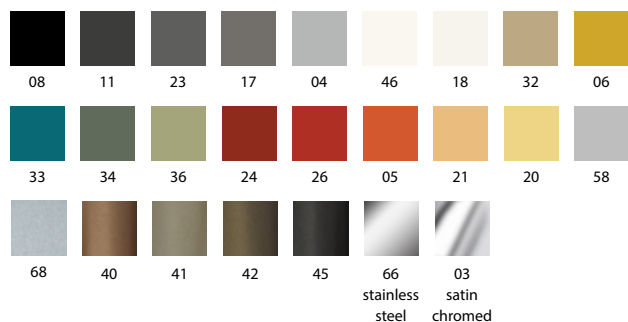

## Dimensions

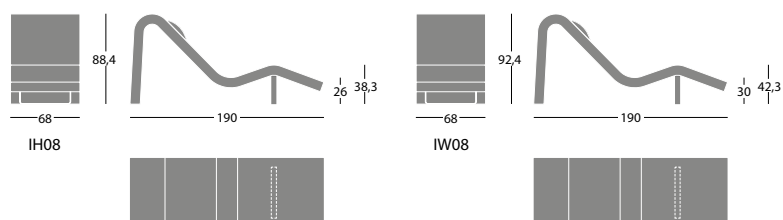

## Additional costs

Upholstery in two different materials  
or two colours of the same material  
Floor anchoring system (per each leg)

## Accessories

Floor anchoring system with stainless steel  
cover for upholstered legs) C0H50



## Customer's own material

For customer's own material, the form at the end of the price list shall apply, to be sent to Segis Spa with the Client's signature.

Solid fabric for 1 pc 556 cm (H.140 cm)  
Upholstery in two colours:  
or 1 pc seat 241 cm (H.140 cm)  
lateral sides 315 cm (H.140 cm)  
Headrest 73 cm (H.140 cm)

# LONGWAY® - Q / R

Bartoli Design / 2007

segis

## Q

Circular bench Ø 136 cm with 3 legs.  
To use only in a modular composition.

## R

Circular bench Ø 180 cm with 4 legs.  
To use only in a modular composition.



Q



R

	Article	Upholstery	Powder coated legs	Satin chromed legs 03	Brushed stainless steel legs 66	pcs / dimensions volume / gross weight product net weight
<b>Module Q</b>	IH09 - H. 38 cm	Gazebo				1 pc / 142x20x164 cm 0,46 m3 / 49 Kg
	IW09 - H. 42 cm	Xtreme Plus / Magnum / Rivet / Sprint / Main Line Flax Blazer / Gingko / Step Melange / Silvertex Steelcut Trio3 C.O. faux leather / C.O.M. (solid colour)				
<b>Module R</b>	IH10 - H. 38 cm	Gazebo				1 pc / 184x20x212 cm 0,78 m3 / 64 Kg
	IW10 - H. 42 cm	Xtreme Plus / Magnum / Rivet / Sprint / Main Line Flax Blazer / Gingko / Step Melange / Silvertex Steelcut Trio3 C.O. faux leather / C.O.M. (solid colour)				

## Accessories

Ganging device, powder coated  
in black 08 art. MGANH0108

## Additional costs

Upholstery in two different materials  
or two colours of the same material  
Floor anchoring system (per each leg)

## Finishes

### Legs

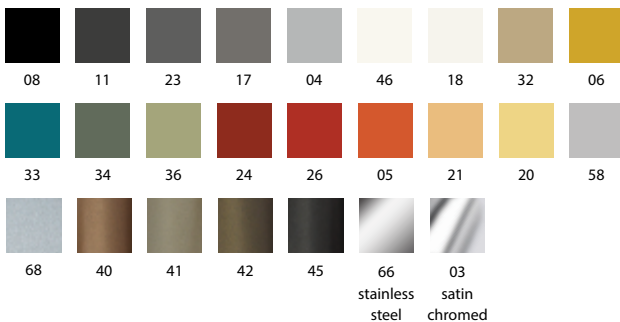

## Customer's own material

For customer's own material, the form at the end of the price list shall apply, to be sent to Segis Spa with the Client's signature.

### Longway Q

Solid fabric for 1 pc: 336 cm (H.140 cm)  
Upholstery in two colours: or 1 pc seat 324cm (H.140 cm) - lateral sides 146 cm (H.140 cm)

### Longway R

Solid fabric for 1 pc 630 cm (H.140 cm)  
Upholstery in two colours: or 1 pc seat 630 cm (H.140 cm) - lateral sides 189 cm (H.140 cm)

## Dimensions

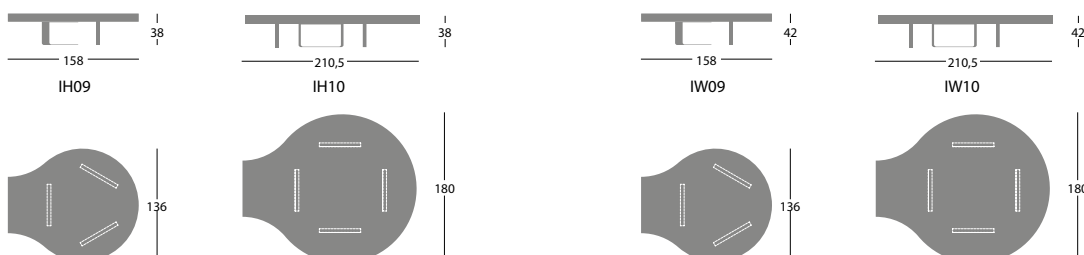

# LONGWAY® - V / W

Bartoli Design / 2007

segls

## Double sided bench

IH11 / IW11 single module with 1 curve and 2 legs

IH12 / IW12 composition with 2 curves and 3 legs



	Article	Upholstery	Powder coated legs	Satin chromed legs 03	Brushed stainless steel legs 66	pcs / dimensions volume / gross weight product net weight
<b>Module V</b> single module with 1 curve and 2 legs	IH11 - H. 38 cm IW11 - H. 42 cm	Gazebo Xtreme Plus / Magnum / Rivet / Sprint / Main Line Flax Blazer / Gingko / Step Melange / Silvertex Steelcut Trio3 C.O. faux leather / C.O.M. (solid colour)				1 pc / 192x58x74 cm 0,82 m3 / 62 kg 47 kg
<b>Module W</b> composition with 2 curves and 3 legs	IH12 - H. 38 cm IW12 - H. 42 cm	Gazebo Xtreme Plus / Magnum / Rivet / Sprint / Main Line Flax Blazer / Gingko / Step Melange / Silvertex Steelcut Trio3 C.O. faux leather / C.O.M. (solid colour)				1 pc / 192x58x74 cm (2 boxes of same dimensions) 1,64 m3 / 126 kg 96 kg

## Finishes

### Legs

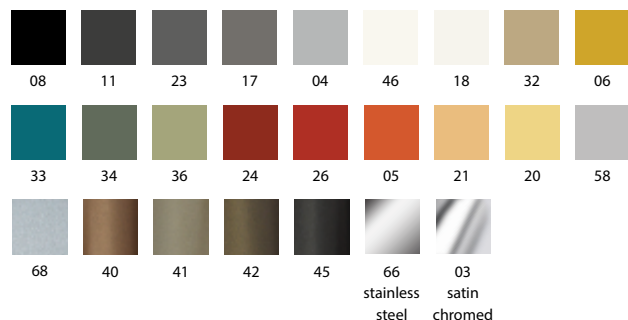

## Accessories

Ganging device, powder coated in black 08 art. MGANH0108

## Additional costs

Upholstery in two different materials or two colours of the same material  
Floor anchoring system (per each leg)

## Customer's own material

For customer's own material, the form at the end of the price list shall apply, to be sent to Segis Spa with the Client's signature.

**Module V**  
Solid fabric for 1 pc 550 cm (H.140 cm)

**Module W**  
Solid fabric for 1 pc 1.100 cm (H.140 cm)  
lateral sides 179 cm (H.140 cm)

## Dimensions

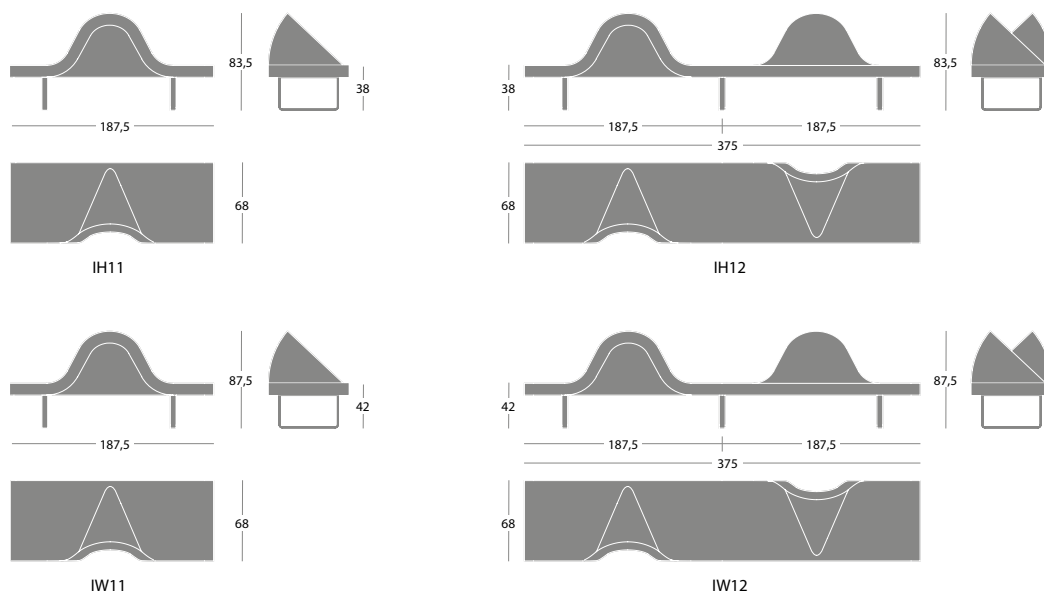

# LONGWAY®



## Modules

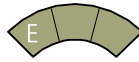
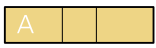

## Compositions

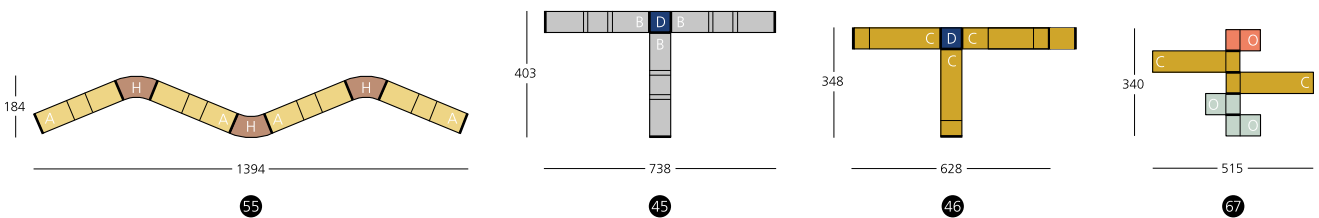
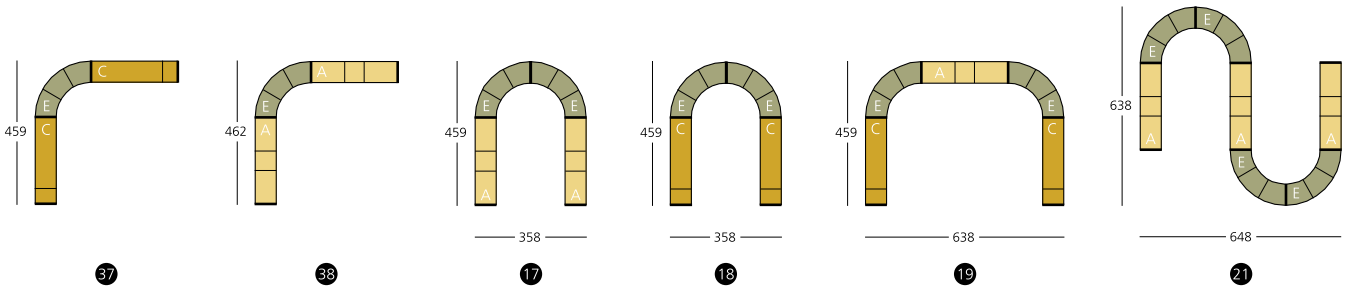
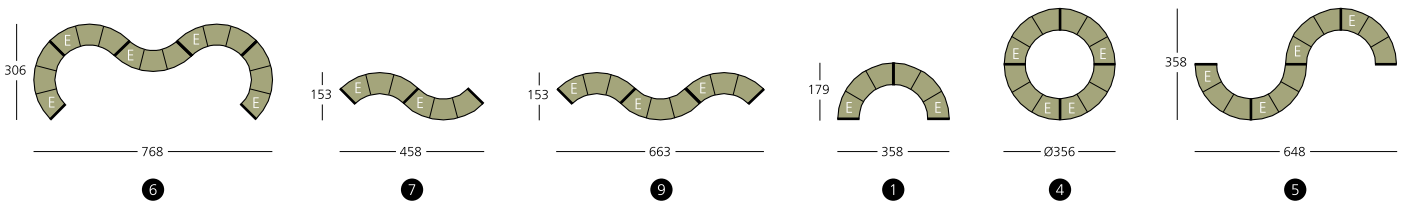
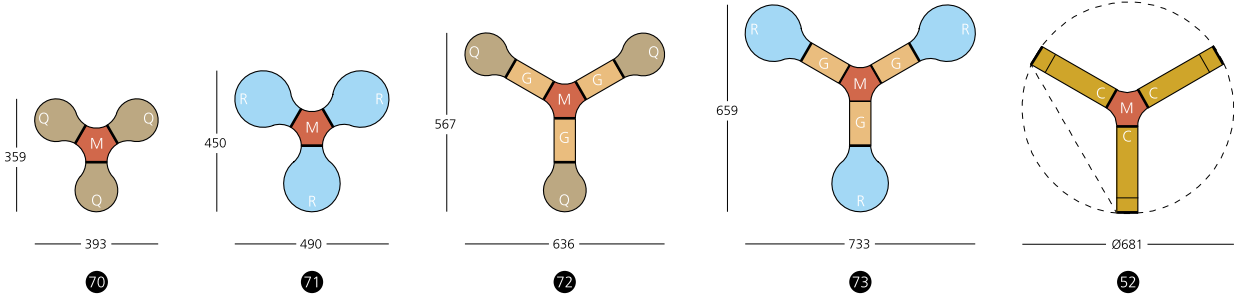
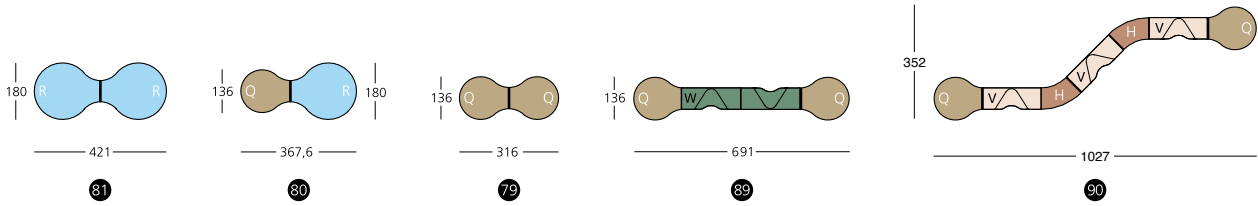

# LONGWAY®

