

Floor standing coat-hanger

Frame: elliptic aluminium tube with die-cast aluminium base in powder coated finish. Umbrella ring with removable water-collector and hanger in thermoplastic material. Version in white finish may have hooks in ivory, anthracite or aluminium as per customer's choice.



Awards:
Adi Design Index

**Wall mounted coat hanger with 4 hooks,**

max load Kg.15 – length 60 cm. Terminal elements and hooks in thermoplastic material.

Frame in aluminium tube in powder coated finish. Version in white finish may have hooks in ivory, anthracite or aluminium as per customer's choice.

	Article	pcs / dimensions volume / gross weight product net weight
Floor standing coat-hanger	E300SP	1 pc / 41x41x176 cm 0,30 m3 / 16 Kg
Floor standing coat-hanger with umbrella's ring	E300SP P	1 pc / 41x41x176 cm 0,30 m3 / 16,2 Kg
Wall-mounted coat hanger with 4 hooks length 60 cm	E300AP	1 pc / 16x16x65 cm 0,02 m3 / 4 Kg

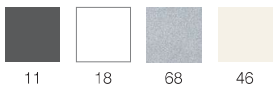
Finishes**Frame****Note**

Art. E300AP Max loading capacity for each hook kg.15

Additional costs

Bicoloured version: frame/hangers
E300SP / E300SP M

Bicoloured version: frame/hangers/
umbrella's ring E300SP P

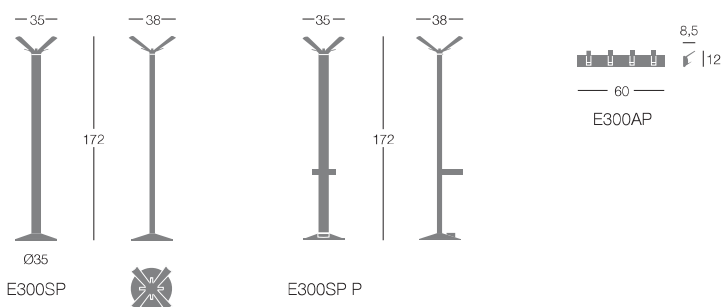
Dimensions

Trolley coat hanger with 24 hooks or with 1 shelf and hooks or with 2 shelves on castors

Frame: steel in powder coated finish
Terminal element and 24 hooks (applied on both sides of the bar) in thermoplastic material (for art. E300SER2/E300SRC)

Bar: aluminium tube.

Shelves: powder coated perforated steel luggage rack and hat rack (for art. E300SRC - E300SRG).

Version in white finish may have hooks in ivory, anthracite or aluminium as per customer's choice.



	Article	pcs / dimensions volume / gross weight product net weight
Trolley coat hanger on wheels with 24 hooks	E300SR 2	1 pc / 16x16x192 cm 1 pc / 62x9x186 cm 0,15 m ³ / 16 Kg
Trolley coat hanger on wheels with top shelf and 24 hooks	E300SR C	1 pc / 16x16x196 cm 1 pc / 62x9x186 cm 0,15 m ³ / 25 Kg
Trolley dress hanger on wheels with 2 shelves	E300SR G	1 pc / 16x16x192 cm 1 pc / 50x15x176 cm 0,18 m ³ / 34 Kg

Finishes

Frame

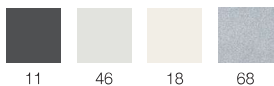

11 46 18 68

Dimensions

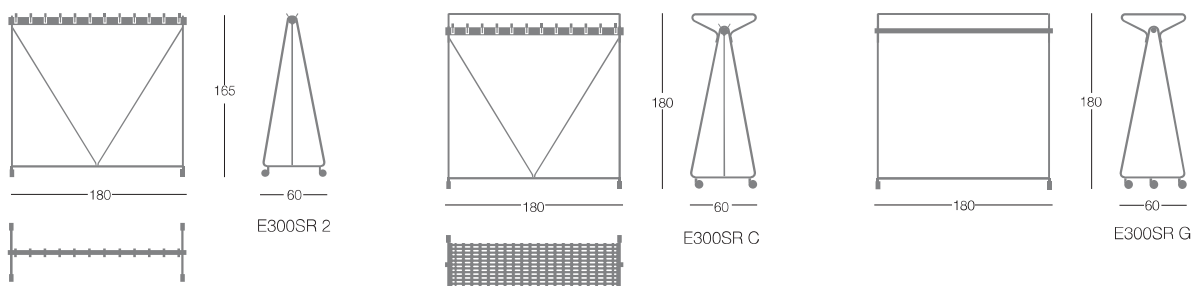

Containing elements available in 2 heights H. 37 / 66 cm.

Frame: steel in powder coated finish
Water collector and gaskets in anthracite self-extinguishing ABS.
Differentiated waste disposal container in polystyrene.
Bin liner inner bag holder in powder coated steel.



Awards:
Adi Design Index



	Article	pcs / dimensions volume / gross weight product net weight
Low wastepaper basket	E400GB	1 pc / 38x25,5x39,5 cm 0,04 m ³ / 3 Kg
High wastepaper basket	E400GA	1 pc / 38x25,5x69,5 cm 0,07 m ³ / 4,7 Kg
Differentiated waste container	E400RD	Packed together with E400GB / GA
Water collector	ME400PVVAS	Packed together with E400GB / GA
Bin liner support	E400RI330 H.33 cm for Art. E400GB E400RI630 H.66 cm for Art. E400GA	Packed together with E400GB / GA

Finishes

Frame

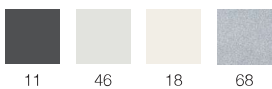

Dimensions

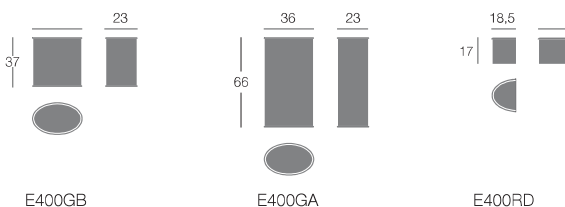

ELLIPSE

Bartoli Design / 2001



Ashtray with sand-collector and waste paper basket.

Frame: steel in powder coated finish.

Chromed sand-tray.

The upper funnel-shaped part is self-extinguishing; in case of fire it stops the oxygen exchange and inhibits flame propagation.

Gaskets in anthracite self-extinguishing ABS.

Bin liner inner bag holder in powder coated steel.



Awards:

Adi Design Index



	Article	pcs / dimensions volume / gross weight product net weight
Ashtray with sand-collector and waste paper basket	E400PG chromed top plate	1 pc / 38x25,5x69,5 cm 0,07 m3 / 5,4 Kg
Bin liner support	E400RI330 H.33 CM for art. E400PG	Packed together with E400PG

Finishes

Frame



11

46

18

68

Dimensions

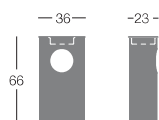

E400PG